

ORIONE Plus 75 | 100 | 150

230V/50Hz | 20 / 28 / 40 Watt



New!

Built In













Orione Plus brings you the most advanced combination of comfort and energy efficiency. With our innovative Optiflame technology, combined with a unique crackling sound and the option of an authentic set of real or ceramic logs, it creates an unrivalled, lifelike fire experience. Featuring energy-saving technologies such as ComfortSaver, offering savings of up to 11% . Meanwhile, Smart Sense technology detects movement in the room and automatically switches the fire off when you're not there. With three sizes and layout options, finding the perfect fire for your home or venue is a breeze and with full control of your fire via smartphone, you can create the perfect atmosphere anytime.

- With three size and layout options
- SmartSense: auto-off feature saves energy by detecting room activity
- ComfortSaver: Maintains room temperature and saves up to 11% energy
- Optional: Black glass back panel for even more intense flames
- With Flame connect APP

Experience Better Living



-  3 installation options. Can be built in as a 1, 2 or 3-sided fireplace
-  Fully adjustable fire image with high-contrast flames for a surprisingly deep and lifelike effect
-  Optiflame technology, soothing flames with a lit glow bed
-  Flames and lamps use energy-efficient LEDs that require no maintenance and can burn separately
-  Comes as standard with an authentic logset
-  Colour alternating flame effects
-  Powerful fan-assisted heating by safe element that provides additional heating on demand
-  Flame Connect app available for smartphone
-  Thanks to the reflective back panel, the flames will be even more intensely
-  7 Day Programmable Timer



Orione Plus 75 | 100 | 150

230V/50Hz | 20 / 28 / 40 Watt

Experience Better Living

Unit Dimensions

DIMENSIONS			
	Width (cm)	Height (cm)	Depth (cm)
Orione Plus 75	79,3	66,6	30,7
Orione Plus 100	104,3	66,6	30,7
Orione Plus 150	154,3	66,6	30,7

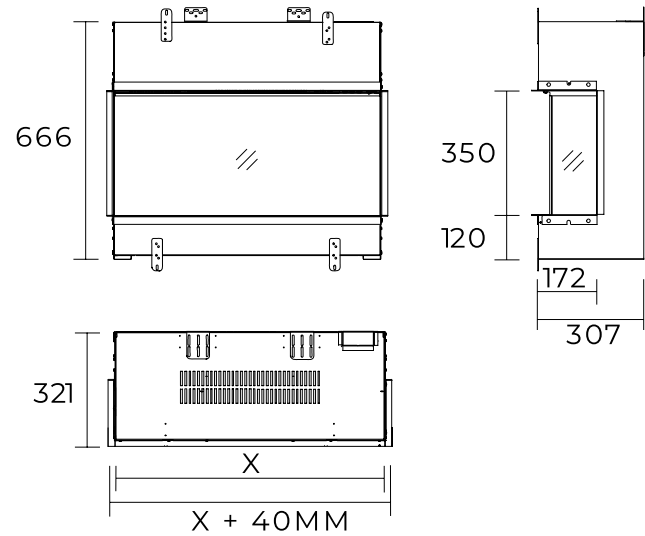

Specifications

TECHNICAL DETAILS	Orione Plus 75	Orione Plus 100	Orione Plus 150
Flame Effect system	Optiflame [®]	Optiflame [®]	Optiflame [®]
Model number	211682	211712	211743
GTIN/UPC	5011139211682	5011139211712	5011139211743
Model	Built-in	Built-in	Built-in
View Type	1-, 2-, or 3-sided	1-, 2-, or 3-sided	1-, 2-, or 3-sided
Colour - Furniture	Black	Black	Black
Media Bed	Authentic logset	Authentic logset	Authentic logset
Viewing window WxH (cm)	75x34	100x34	150x34
Build in dim (WxHxD) (cm)	79,3x66,6x30,7	104,3x66,6x30,7	154,3x66,6x30,7
Heating function	Yes	Yes	Yes
Heating Element	Yes	Yes	Yes
Remote Control	Yes	Yes	Yes
Manual Operation on the fireplace possible	Yes	Yes	Yes
Lighting Module	LED	LED	LED
Sound	Yes	Yes	Yes
Media Bed Flame Colours	Yes	Yes	Yes
Heat Setting 1 in Watts	1500	1500	1500
Heat Setting 2 in Watts	-	-	-
Power consumption (flame effect) (Watt)	20	28	40
Wattage	1500	1500	1500
Voltage	230V/50Hz	230V/50Hz	230V/50Hz
Unpacked Weight (kg)	38	50	70
Plug Length	1,5 m	1,5 m	1,5 m
Warranty	2 years	2 years	2 years